

INSTRUCTION MANUAL

MW150 & MW151 MAX pH / ORP / Temperature Bench Meters





THANK YOU for choosing Milwaukee Instruments!

This instruction manual will provide you the necessary information for correct use of the meters.

All rights are reserved. Reproduction in whole or in part is prohibited without the written consent of the copyright owner, Milwaukee Instruments Inc., Rocky Mount, NC 27804 USA.

TABLE OF CONTENTS

1. PRELIMINARY EXAMINATION	4
2. INSTRUMENT OVERVIEW	5
3. SPECIFICATIONS	6
4. FUNCTIONAL & DISPLAY DESCRIPTION	8
5. PROBE DESCRIPTION.....	14
6. GENERAL OPERATIONS.....	16
6.1. POWER CONNECTION & BATTERY MANAGEMENT	16
6.2. MOUNTING THE ELECTRODE HOLDER	16
6.3. CONNECTING THE PROBES	17
6.4. ELECTRODE CARE & MAINTENANCE.....	18
7. SETUP	20
7.1. GENERAL SETUP	20
7.2. MW151 SPECIFIC SETUP	24
8. pH	27
8.1. PREPARATION	27
8.2. CALIBRATION	27
8.3. MEASUREMENT	30
8.4. WARNINGS & MESSAGES.....	31
9. ORP	35
9.1. PREPARATION	35
9.2. MEASUREMENT	35
10. MEMORY FUNCTIONS (MW150).....	36
11. LOGGING (MW151).....	37
11.1. TYPES OF LOGGING	37
11.2. DATA MANAGEMENT	39
12. GLP	46
13. TROUBLESHOOTING.....	48
14. ACCESSORIES.....	49
CERTIFICATION.....	50
RECOMMENDATION	50
WARRANTY.....	50

1. PRELIMINARY EXAMINATION

Each bench meter is delivered in a cardboard box and is supplied with:

- **MA917B/1** Double junction refillable pH electrode
- **MA831R** Stainless steel temperature probe
- **M10004** pH 4.01 buffer solution (sachet)
- **M10007** pH 7.01 buffer solution (sachet)
- **M10010** pH 10.01 buffer solution (sachet)
- **M10016** Electrode cleaning solution (sachet)
- **MA9315** Electrode holder
- Graduated pipette
- 12 VDC adapter
- USB cable (**MW151**)
- Instrument quality certificate
- Instruction manual

2. INSTRUMENT OVERVIEW

MW150 and **MW151** pH / ORP / Temperature bench meters perform accurate measurements and present a series of new diagnostic features for improved reliability.

- Alphanumeric LCD for intuitive information display
- Built-in rechargeable battery with an 8-hour capacity
- Auto-off feature to prolong battery life
- Internal clock and date to keep track of different time-dependent functions (calibration timestamp, calibration time-out)
- Dedicated GLP key to store and recall data on system status

MW150 offers simplified pH measurements that are ideal for anyone who requires rapid and reliable results but works on a tight budget.

MW151 has a wider range of features and can be used in more complex applications where certain requirements need to be met.

	MW151	MW150
Measurement resolution	0.01 or 0.001 pH	0.01 pH
Calibration points	Up to 5-point	Up to 3-point
Custom buffers	2	-
Electrode condition	Detailed	-
Logging type	On demand, Stability, Interval Log space for 1000 records	Last reading
PC connection	2 USB ports	-

3. SPECIFICATIONS

	MW150	MW151
Range *	pH	-2.00 to 20.00 pH
	mV	-2.000 to 20.000 pH
	Temp.	±2000.0 mV
Resolution	pH	-20.0 to 120.0 °C (-4.0 to 248.0 °F)
	mV	±2000.0 mV
	Temp.	-20.0 to 120.0 °C (-4.0 to 248.0 °F)
Accuracy @ 25°C (77°F)	pH	0.01 pH
	mV	0.001 pH
	Temp.	0.1 mV
pH calibration	pH	±0.01 pH
	mV	±0.002 pH
	Temp.	±1 mV
Temperature compensation	pH	±0.4 °C / ±0.8 °F
	mV	±0.4 °C / ±0.8 °F
	Temp.	±0.4 °C / ±0.8 °F
Log	pH	up to 3-point automatic 7 standard buffers (pH 1.68, 4.01, 6.86, 7.01, 9.18, 10.01, 12.45) no custom buffers
	mV	up to 5-point automatic 7 standard buffers (pH 1.68, 4.01, 6.86, 7.01, 9.18, 10.01, 12.45) 2 custom buffers
	Temp.	Automatic -20.0 to 120.0°C (-4.0 to 248.0 °F) Manual (without temperature probe)
PC connection	pH	Automatic -20.0 to 120.0°C (-4.0 to 248.0 °F) Manual (without temperature probe)
	mV	Automatic -20.0 to 120.0°C (-4.0 to 248.0 °F) Manual (without temperature probe)
	Temp.	Automatic -20.0 to 120.0°C (-4.0 to 248.0 °F) Manual (without temperature probe)
Power supply	pH	up to 1000 log records (stored in up to 100 lots) Log on demand, 200 logs Log on stability, 200 logs Interval logging, 1000 logs
	mV	Maximum 1000 log records (stored in up to 100 lots) Log on demand, 200 logs Log on stability, 200 logs Interval logging, 1000 logs
	Temp.	Maximum 1000 log records (stored in up to 100 lots) Log on demand, 200 logs Log on stability, 200 logs Interval logging, 1000 logs
Battery life	pH	1 USB port, 1 micro USB port
	mV	12 VDC adapter
	Temp.	12 VDC adapter, 5 VDC USB adapter
Auto-off	pH	8 hours
	mV	5, 10, 30, 60 min. or off
	Temp.	5, 10, 30, 60 min. or off
Environment	pH	0 to 50 °C; max RH 95%
	mV	0 to 50 °C; max RH 95%
	Temp.	0 to 50 °C; max RH 95%
Dimensions	pH	230 x 160 x 95 mm (9.0 x 6.3 x 3.7")
	mV	230 x 160 x 95 mm (9.0 x 6.3 x 3.7")
	Temp.	230 x 160 x 95 mm (9.0 x 6.3 x 3.7")
Weight	pH	0.9 kg (2.0 lb.)
	mV	0.9 kg (2.0 lb.)
	Temp.	0.9 kg (2.0 lb.)
Warranty	pH	3 years
	mV	3 years
	Temp.	3 years

* Limits will be reduced to actual sensor limits

PROBE SPECIFICATIONS

pH electrode MA917B/1	pH range	0 to 14 pH
	Temperature range	0 to 70 °C (32 to 158 °F)
	Operating temperature	20 to 40 °C (68 to 104 °F)
	Reference electrolyte	KCl 3.5M
	Reference junction	Ceramic, single
	Reference type	Double, Ag/AgCl
	Maximum pressure	0.1 bar
	Body	Shaft: glass; tip shape: sphere
	Connector	BNC
	Dimensions	Shaft length: 120 mm (5.5"); Ø 12 mm (0.5")
	Cable	Length 1 m (3.2 ft)
Temperature probe MA831R	Temperature sensor	NTC10K
	Body	Stainless steel
	Connector	RCA
	Dimensions	Total length: 190 mm (7.5") Active part: 120 mm (5.5"); Ø 3,6 mm (1.4")
	Cable	Length 1 m (3.2 ft)

4. FUNCTIONAL & DISPLAY DESCRIPTION

Front Panel MW150

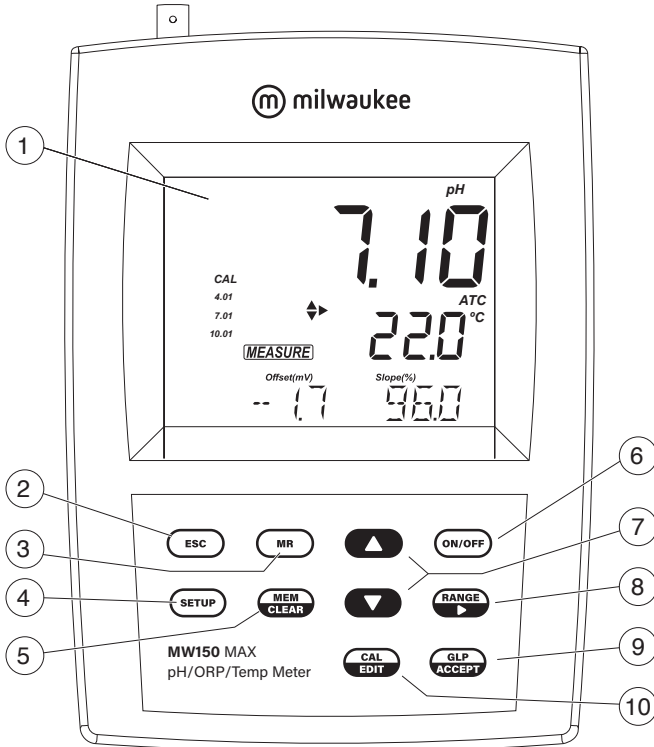

1. Liquid Crystal Display (LCD)
2. ESC key, to exit current mode
3. MR key, to recall the stored value from memory
4. SETUP key, to enter setup mode
5. MEM/CLEAR key, to store the reading or to clear calibration or memory
6. ON/OFF key
7. ▲▼ directional keys for menu navigation, select setup parameters and calibration buffers
8. RANGE/► key, to select setup parameters and toggle between measurement units
9. GLP/ACCEPT key, to enter GLP or to confirm selected action
10. CAL/EDIT key, to enter/edit calibration settings, edit setup settings

Front Panel MW151

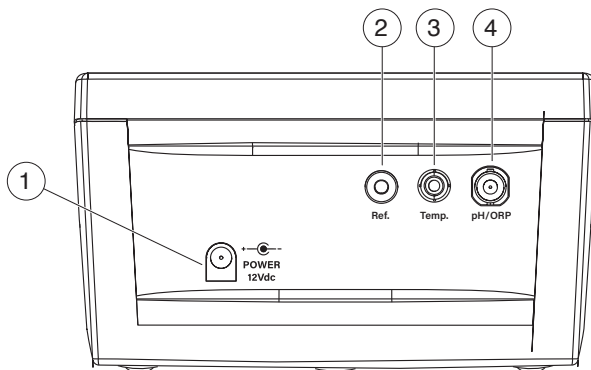

1. Liquid Crystal Display (LCD)
2. ESC key, to exit current mode
3. RCL key, to recall the logged values
4. SETUP key, to enter setup mode
5. LOG/CLEAR key, to log the reading or to clear calibration or logging
6. ON/OFF key
7. ▲▼ directional keys for menu navigation, select setup parameters and calibration buffers
8. RANGE/► key, to select setup parameters and toggle between measurement units
9. GLP/ACCEPT key, to enter GLP or to confirm selected action
10. CAL/EDIT key, to enter/edit calibration settings, edit setup settings

Rear Panel MW150

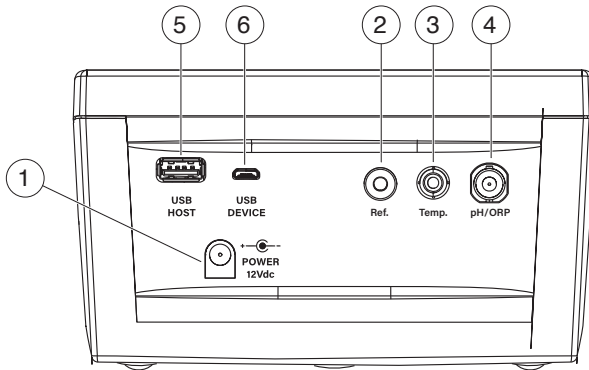

1. Power supply socket
2. Reference electrode socket
3. Temperature probe socket
4. BNC electrode connector

Rear Panel MW151



1. Power supply socket
2. Reference electrode socket
3. Temperature probe socket
4. BNC electrode connector
5. USB port
6. Micro-USB port

Display Description MW150

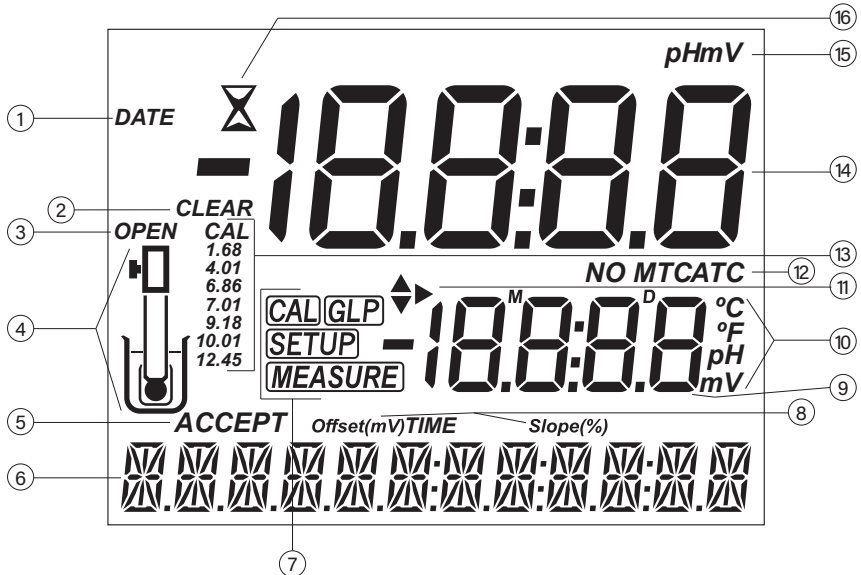

1. DATE tag
2. CLEAR message/calibration/memory
3. OPEN is displayed when the electrode cap has to be removed.
Refill cap is displayed blinking before calibration.
4. Electrode symbol
5. ACCEPT tag
6. Third LCD line, message area
7. Mode tags
8. Offset/slope indicators
9. Second LCD line, temperature measurement
10. Temperature and measurement units
11. Arrow tags, to help user select required information
12. Temperature compensation status (MTC, ATC)
13. pH calibration buffers
14. First LCD line, measurement reading
15. Measurement units
16. Stability indicator

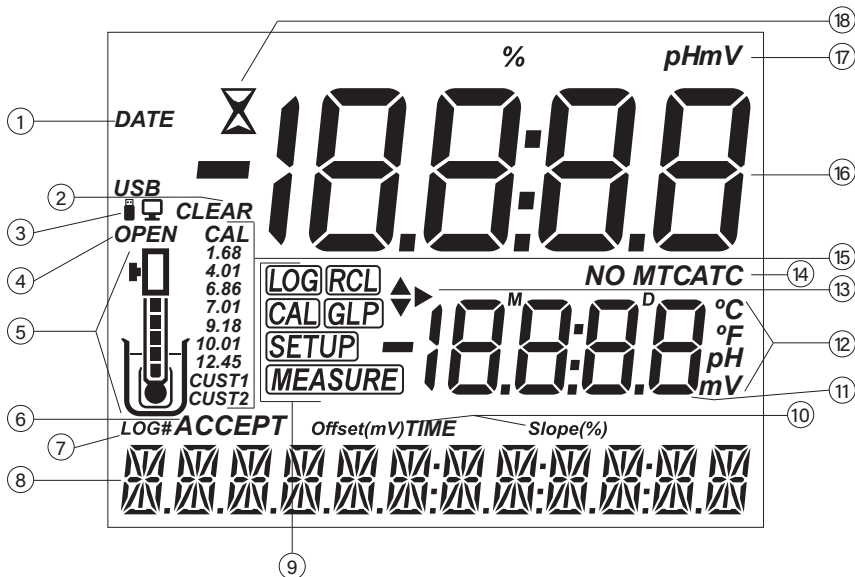
Display Description MW151

1. DATE tag
2. CLEAR message/calibration/memory
3. USB connections status
4. OPEN is displayed when electrode cap has to be removed.
Refill cap is displayed blinking before calibration.
5. Electrode symbol, filled in segments indicate electrode condition
6. ACCEPT tag
7. Log tag
8. Third LCD line, message area
9. Mode tags
10. Offset/slope indicators
11. Second LCD line, temperature measurement
12. Temperature and measurement units
13. Arrow tags, to help user select required information
14. Temperature compensation status (MTC, ATC)
15. pH calibration buffers
16. First LCD line, measurement reading
17. Measurement units
18. Stability indicator

5. PROBE DESCRIPTION

MA917B/1 for pH measurement.

- Double junction design, reduces risk of clogging with the reference cell physically separated from the intermediate electrolyte.
- Refillable, with **MA9011** 3.5M KCl. This solution is silver free. Silver can cause silver precipitate to form at the junction resulting in clogging. Clogging causes erratic and slow readings. The ability to refill the electrolyte also extends the life of the electrode.
- Glass body, is easily cleaned and resistant to chemicals.
- Round tip, provides the largest possible surface area for faster readings and is well suited to testing liquid samples.

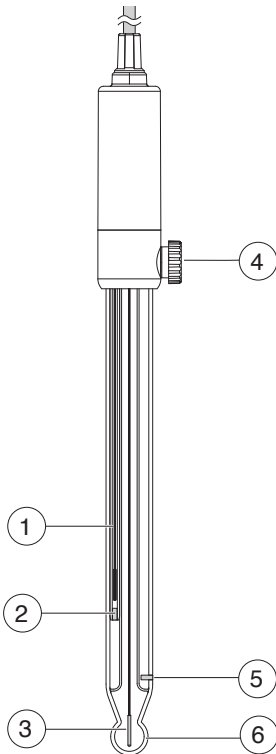

1. Reference wire
2. Inner reference junction
3. Sensing wire
4. Reference refill cap
5. Outer reference junction
6. Glass bulb

MA831R for temperature measurement and automatic temperature compensation (ATC).

- Made of stainless steel for corrosion resistance
- Used in conjunction with the pH electrode to utilize the instrument's ATC capability

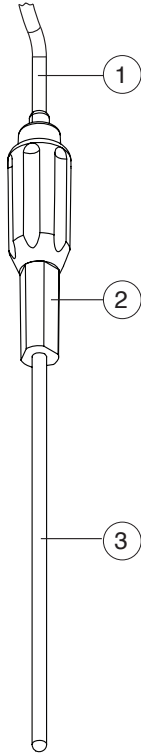

1. Cable
2. Handle
3. Stainless steel tube

6. GENERAL OPERATIONS

6.1. POWER CONNECTION & BATTERY MANAGEMENT

MW150 and **MW151** can be powered from the supplied 12 VDC adapter, through a PC USB port or standard 5V USB charger (**MW151** only) or from the built-in rechargeable battery. The built-in rechargeable battery provides about 8 hours of continuous use. Fully charge the battery before first use.

To conserve battery, the meter will turn off automatically after 10 minutes of inactivity. To configure this option see Auto Off in GENERAL SETUP section.

- Press ON/OFF to turn the instrument on.
All LCD segments are displayed briefly and the instrument enters measurement mode.
- After measurement, switch the meter off, clean the electrode and store it with a few drops of **MA9015** storage solution in the protection cap.

6.2. MOUNTING THE ELECTRODE HOLDER

- Take the **MA9315** electrode holder from the box.
- Identify the metal plate (4) with the integrated pin (5) and the screw (2).
The plate may be attached to either sides of the meter, left (L) or right (R).
- Turn the meter over, with the display facing down.

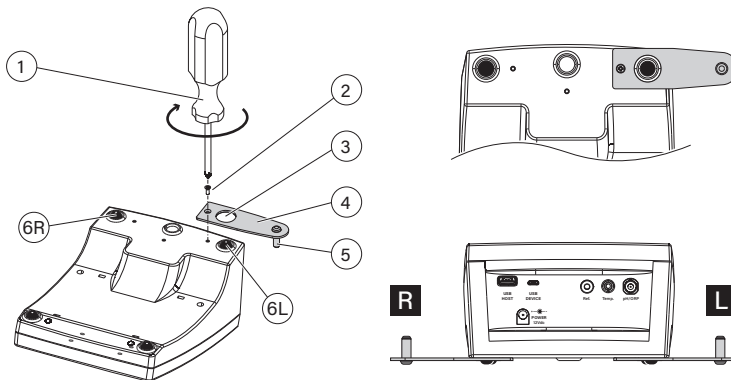

- Align the rubber foot (6R or 6L) with the hole (3) on the plate (4). Make sure the pin (5) is facing down.
- Use a screwdriver (1) to tighten the screw (2) and lock in place.

- Position the meter with the display facing up.
- Take the electrode holder (7) and insert it into the pin (5). The pin securely holds the electrode holder in place.
- For increased arm rigidity, tighten the metal knobs (8) on both sides.

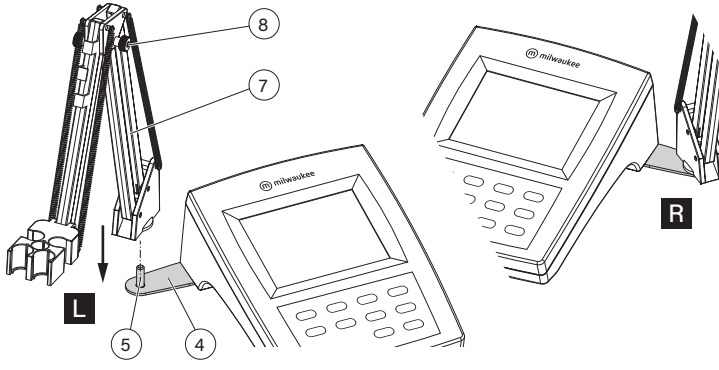

6.3. CONNECTING THE PROBES

6.3.1. MA917B/1 pH Probe

MA917B/1 is connected to the meter through a BNC connector (labeled pH/ORP).

With the meter off:

- Connect the probe to the BNC socket on the top right of the meter.
- Align and twist the plug into the socket.
- Place the probe into the holder and secure the cable in clips.

6.3.2. MA831R Temperature Probe

MA831R is connected to the meter through a RCA connector (labeled Temp.)

With the meter off:

- Connect the probe to the RCA socket on the top right of the meter.
- Push the plug into the socket.
- Place the probe into the holder and secure the cable in clips.

6.4. ELECTRODE CARE & MAINTENANCE

Calibrating & Conditioning

Maintaining a pH electrode is critical to ensure proper and reliable measurements. Frequent 2- or 3-point calibrations are recommended to ensure accurate and repeatable results.

Prior to using the electrode for the first time

1. Remove the protective cap. Do not be alarmed if salts deposits are present, this is normal. Rinse the electrode with distilled or deionized water.
2. Place the electrode in a beaker containing **MA9016** Cleaning solution for a minimum of 30 minutes.

***Note:** Do not condition a pH electrode in distilled or deionized water as this will damage the glass membrane.*

3. For refillable electrodes, if the refill solution (electrolyte) has dropped more than 2½ cm (1") below the fill hole, add the appropriate electrolyte solution.
4. After conditioning, rinse the sensor with distilled or deionized water.

***Note:** To ensure quick response and avoid cross-contamination, rinse the electrode tip with the solution to be tested before measurement.*

Best practice when handling an electrode

- Electrodes should always be rinsed between samples with distilled or deionized water.
- Do not wipe an electrode as wiping can cause erroneous readings due to static charges.
- Blot the end of the electrode with lint-free paper.

Electrode Storage

To minimize clogging and ensure quick response time, the glass bulb and the junction should be kept hydrated.

Add a few drops of **MA9015** Storage solution to the protective cap. Replace the storage cap when the probe is not in use.

***Note:** Never store the probe in distilled or deionized water.*

Regular Maintenance

- Inspect the probe. If cracked, replace the probe.
- Inspect the cable. Cable and insulation must be intact.
- Connectors should be clean and dry.
- Rinse off salt deposits with water.
- Follow storage recommendations.

For refillable electrodes:

- Refill the electrode with fresh electrolyte solution (see the electrode's specifications to select the correct refilling solution).
- Keep the electrode upright for 1 hour.
- Follow the storage procedure above.

If electrodes are not maintained correctly both accuracy and precision are affected. This can be observed as a steady decrease in the slope of the electrode.

The slope (%) indicates the sensitivity of the glass membrane, the offset value (mV) indicates the age of electrode and provides an estimation when the probe needs to be changed. The slope percentage is referenced to the ideal slope value at 25 °C.

Milwaukee Instruments recommends that the offset does not exceed ± 30 mV and that the slope percentage is between 85-105%.

When the slope value drops below 50 mV per decade (85% slope efficiency) or the offset at the zero point exceeds ± 30 mV, reconditioning may improve performance, but a change of electrode may be necessary to ensure accurate pH measurements.

Electrode Status (MW151)

MW151 displays electrode status after calibration. See probe icon on the LCD screen.

The assessment remains active for 12 hours and is based on the electrode offset and slope during calibration.

	5 bars	Excellent condition
	4 bars	Very good condition
	3 bars	Good condition
	2 bars	Fair condition
	1 bar	Poor condition
	1 bar blinking	Very poor condition
	no bar	Not calibrated

Recommendations:

- **1 bar:** Clean the electrode and recalibrate. If there is still only 1 bar or 1 bar blinking after recalibration, replace the probe.
- **No bar:** Instrument was not calibrated on current day or a one-point calibration was performed with previous calibration not yet deleted.

7. SETUP

To configure the meter settings, modify default values or set measurement parameters:

- Press SETUP to enter (or exit) Setup mode.
- Use ▲▼ keys to navigate the menus (view parameters).
- Press CAL/EDIT to enter Edit mode (modify parameters).
- Press RANGE/▶ key to select between options.
Use ▲▼ keys to modify values (value being modified is displayed blinking).
- Press GLP/ACCEPT to confirm and save changes (ACCEPT tag is displayed blinking).
- Press ESC (or CAL/EDIT again) to exit Edit mode without saving (return to menu).

7.1. GENERAL SETUP

pH Information

Options: On (default) or Off (disabled)

Use ▲▼ keys to select.

Displays pH buffer calibration information. When enabled, the electrode symbol displays the electrode condition (**MW151** only).

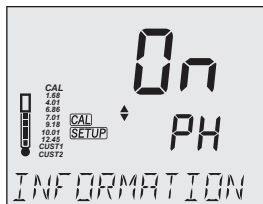

Calibration Expired Warning

Options: 1 to 7 days (default) or off

Use ▲▼ keys to select the number of days since last calibration has elapsed.

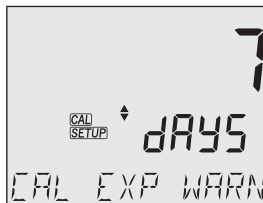

Out of Calibration Range Warning

Options: On (default) or Off (disabled)

Use ▲▼ keys to select.

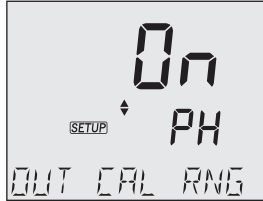

Date

Options: year, month or day

Press RANGE/▶ to select. Use ▲▼ keys to modify the values.

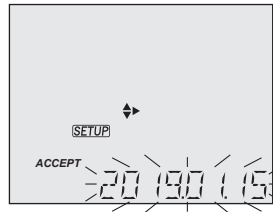
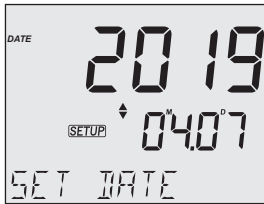

Time

Options: hour, minute or second

Press RANGE/▶ to select. Use ▲▼ keys to modify the values.

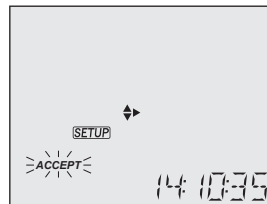

Auto Off

Options: 5, 10 (default), 30, 60 minutes or off

Use ▲▼ keys to select the time.

The meter will power off after set period of time.

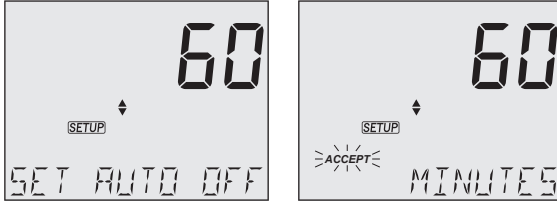

Sound

Options: enable (default) or disable

Use ▲▼ keys to select.

When pressed, each key will emit a short acoustic signal.

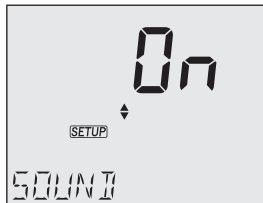

Temperature Unit

Options: °C (default) or °F

Use ▲▼ keys to select the unit.

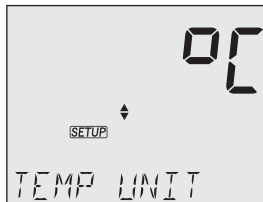

LCD Contrast

Options: 1 to 9 (default)

Use ▲▼ keys to set LCD contrast values.

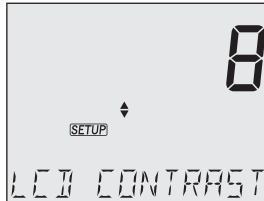

Default Values

Resets meter settings to factory defaults.

Press GLP/ACCEPT to restore the default values. "RESET DONE" message confirms that the meter performs with default settings.

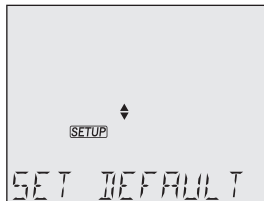

Instrument Firmware Version

Displays the installed firmware version.



Meter ID / Serial Number

Use ▲▼ keys to assign a meter ID from 0000 to 9999.

Press RANGE/▶ to view the serial number.

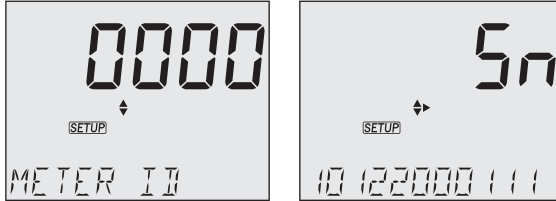

7.2. MW151 SPECIFIC SETUP

Export to PC / Log on Meter

Options: Export to PC and Log on Meter

With the micro USB cable connected, press SETUP. Press CAL/EDIT to enter Edit mode.

Use ▲▼ keys to select.

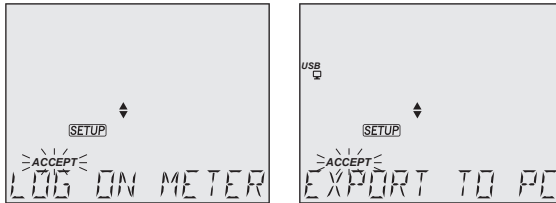

Log Type

Options: INTERVAL (default), MANUAL or STABILITY

Press RANGE/▶ to select between options.

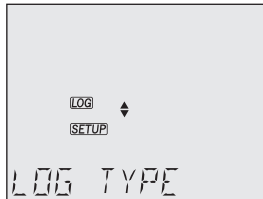

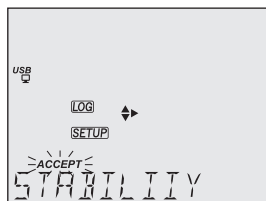
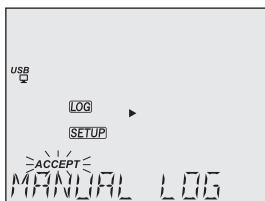

Use ▲▼ keys to set time interval: 5 (default), 10, 30 sec. or 1, 2, 5, 15, 30, 60, 120, 180 min.

Use ▲▼ keys to select stability type: fast (default), medium or accurate.

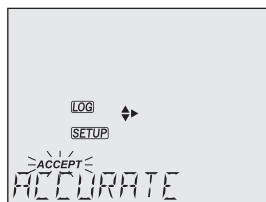
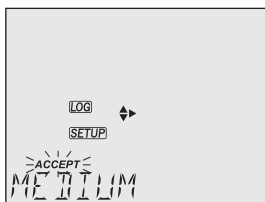
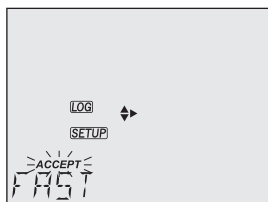

First Custom Buffer

Press RANGE/▶ to set a default buffer value as starting value.

Use ▲▼ keys to set the value of the first custom buffer.

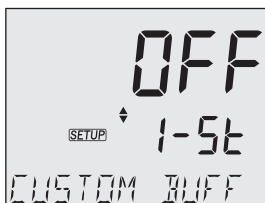

Second Custom Buffer

Press RANGE/▶ to set a default buffer value as starting value.

Use ▲▼ keys to set the value of the second custom buffer.

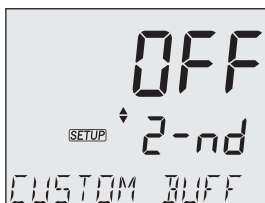

pH Resolution

Options: 0.01 (default) and 0.001

Use ▲▼ keys to select.

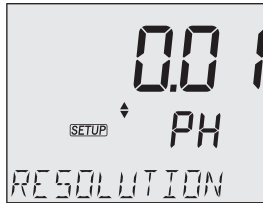

Separator Type

Option: comma (default) or semicolon. Use ▲▼ keys to select.

Change the columns separator type for the CSV file.

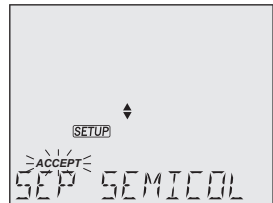
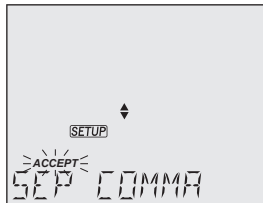
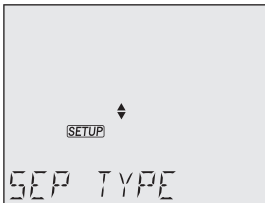

8. pH

8.1. PREPARATION

MW150: Up to 3-point calibration using 7 standard buffers.

MW151: Up to 5-point calibration using 7 standard buffers and 2 custom buffers (CUST1 and CUST2).

1. Prepare two clean beakers. One beaker is for rinsing and one for calibration.
2. Pour small quantities of the selected buffer solution into each beaker.
3. Remove the protective cap and rinse the probe with the buffer solution for the first calibration point.

8.2. CALIBRATION

General Guidelines

For better accuracy, frequent calibrations are recommended.

The probe should be recalibrated at least once a week, or:

- Whenever is replaced
- After testing aggressive samples
- When high accuracy is required
- When the calibration time out has expired

Procedure

1. Place the pH probe tip approximately 4 cm (1½") into the buffer solution and stir gently. For a 2-point calibration, use the pH 7.01 (pH 6.86 for NIST) buffer first. Press CAL/EDIT to enter Calibration mode. Buffer value and "WAIT" message are displayed blinking. If required, use the ▲▼ keys to select a different buffer value.

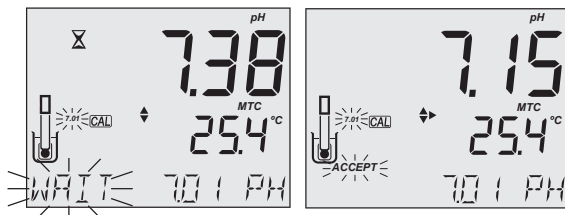

2. When the reading is stable and close to the selected buffer, the ACCEPT tag is displayed blinking. Press GLP/ACCEPT to confirm calibration.

- After the first calibration point has been confirmed, the calibrated value is displayed on the first LCD line and the second expected buffer value on the third LCD line (i.e. pH 4.01). The value of the first buffer is set while the second expected buffer value is displayed blinking on the screen.

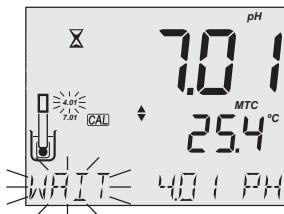

For one-point calibration, press CAL/EDIT to exit calibration. The meter stores the calibration and returns to Measurement mode.

To continue calibrating with additional buffers, rinse and place the pH probe tip approximately 4 cm (1½") into the second buffer solution and stir gently.

If needed, use the ▲▼ keys to select a different buffer value.

Note: When attempting to calibrate with a different buffer (not yet used), the previously used buffers are displayed blinking.

Follow the same steps for 2- or 3-point calibration.

For improved accuracy, a minimum of 2-point calibration is recommended.

Note: When performing a new calibration (or adding to an existing calibration) the first calibration point is treated as an offset. Press CAL/EDIT after the first or second calibration point has been confirmed, and the instrument stores the calibration data and returns to Measurement mode.

5-Point Calibration (MW151)

The 3-point calibration procedure can be continued up to 5-point following the same steps.

For accurate pH measurements, 5-point calibration is recommended and a minimum of 2-point calibration is suggested.

Custom Buffers (MW151)

This feature has to be enabled in Setup. Temperature compensation of custom buffers is set to the value of 25°C.

Calibrating with custom buffers:

- Press RANGE/▶. The custom buffer value is displayed blinking on the third LCD line.

- Use the ▲▼ keys to modify the value based on the temperature reading. The buffer value is updated after 5 seconds.

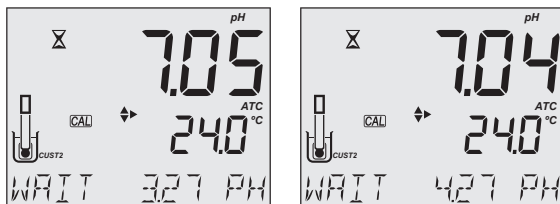

Note: When using custom buffers, CUST1 and CUST2 tags are displayed. If only one custom buffer is used, CUST1 is displayed together with its value.

Clear Calibration

1. Press CAL/EDIT to enter Calibration mode.
2. Press LOG/CLEAR (MEM/CLEAR).
ACCEPT tag is displayed blinking and "CLEAR CAL" message is displayed.
3. Press GLP/ACCEPT to confirm.
"PLEASE WAIT" message is displayed followed by the "NO CAL" confirmation screen.

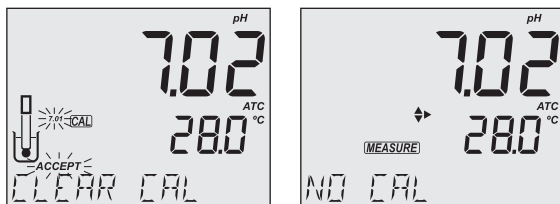

Expired Calibration

The instrument has a real time clock (RTC) to monitor the time elapsed since the last pH calibration. The RTC is reset every time the instrument is calibrated and the "expired calibration" status is triggered when the meter detects calibration time out. See GENERAL SETUP, Calibration Expired Warning for details.

The "CAL EXPIRED" warns the user that the instrument should be recalibrated.

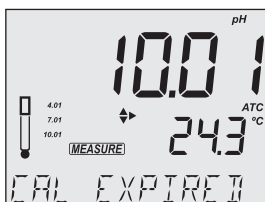

8.3. MEASUREMENT

Remove the probe protective cap and place the tip approximately 4 cm (1 ½") into the sample. It is recommended to wait for the sample and the pH probe to reach the same temperature.

If necessary, press the RANGE/▶ until the display changes to the pH mode. Allow the reading to stabilize (X stability tag to turn off).

The LCD will display:

- Measurement and temperature readings.
- Temperature compensation mode (MTC or ATC).
- Buffers used (if option enabled in Setup).
- Electrode condition (if option enabled in Setup, **MW151** only).
- The third LCD line displays: mV offset & slope values, time and date of measurement, battery status. Use the ▲▼ keys to scroll between them.

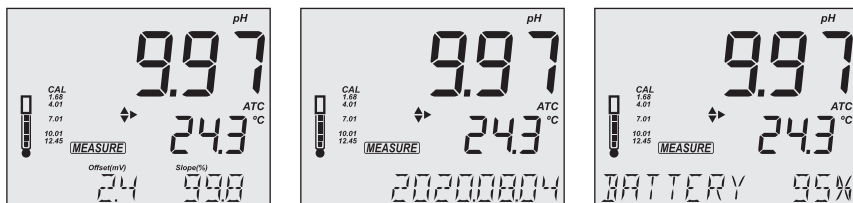

For best results is recommended to:

- Calibrate the probe before use and recalibrate periodically
- Keep the electrode hydrated
- Rinse the probe with the sample before use
- Soak in **MA9015** Storage solution for at least 1 hour before measurement

MTC mode

When the probe is not connected the "NO T. PROBE" message is displayed. The MTC tag and the default temperature (25 °C) with blinking temperature unit are displayed.

1. Press CAL/EDIT and use the ▲▼ keys to set the temperature value manually.
2. Press GLP/ACCEPT to confirm or press ESC (or CAL/EDIT again) to exit without saving.

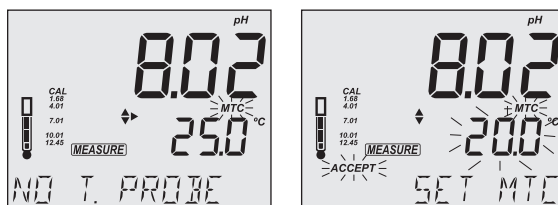

Note: The temperature value used for MTC can be set only when “NO T. PROBE” message is displayed.

8.4. WARNINGS & MESSAGES

The Calibration Check feature flags diagnostic messages during a calibration. As electrode aging is usually a slow process, differences between previous calibrations are likely due to a temporary problem with the probe or buffers.

Messages Displayed During Calibration

- “WRONG BUFFER” message is displayed blinking when the difference between the pH reading and selected buffer value is significant. Check if correct calibration buffer has been used.

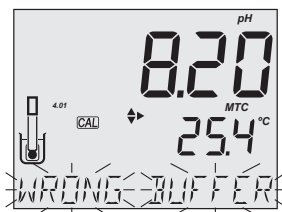

- “WRONG OLD POINTS INCONSISTENT” is displayed if there is discrepancy between new calibration value and old value recorded when calibrating with the same probe in a buffer of the same value.

Clear the previous calibration and calibrate with fresh buffers. See Clear Calibration section for details.

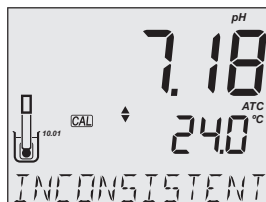
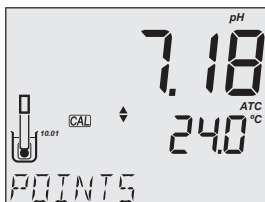
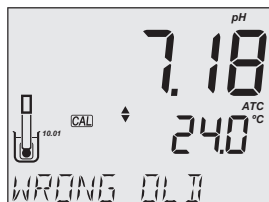

- “CLEAN ELEC” indicates poor electrode performance (the offset is out of the accepted window, or the slope is under the accepted lower limit). Clean the probe to improve response time. See ELECTRODE CARE & MAINTENANCE for details. Repeat calibration after cleaning.

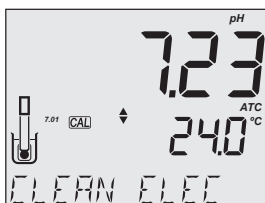

- “CHECK PROBE CHECK BUFFER” is displayed when the electrode’s slope exceeds the highest accepted slope limit. Inspect the electrode and make sure the buffer solution is fresh. Clean the probe to improve response time.

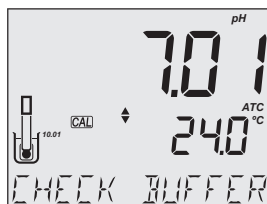
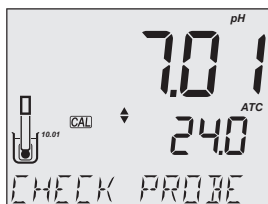

- “BAD ELEC” is displayed when after cleaning, the electrode’s performance has not improved. Replace the probe.

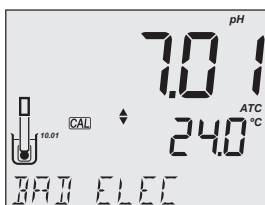

- "WRONG STANDARD TEMPERATURE" is displayed when buffer temperature is out of range. The calibration buffers are affected by temperature changes. During calibration, the instrument will automatically calibrate to the pH value corresponding to the measured temperature but compensate it to the value of 25 °C.

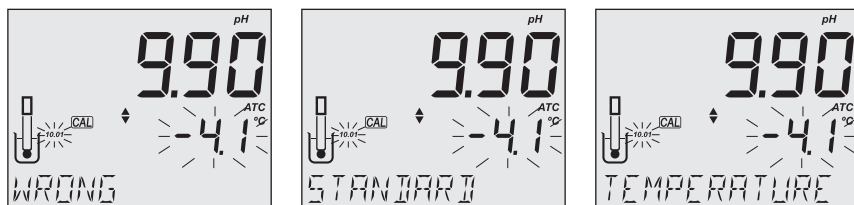

- "CONTAMINATED BUFFER" is displayed when the buffer is contaminated. Replace the buffer with a new one and continue the calibration.

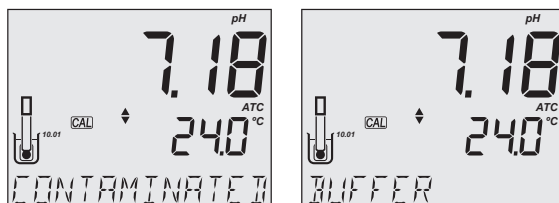

- "VALUE USED BY CUST1" or "VALUE USED BY CUST2" is displayed when setting a CUST1 or CUST2 value already saved for a custom buffer. Make sure that set custom buffers have different values.

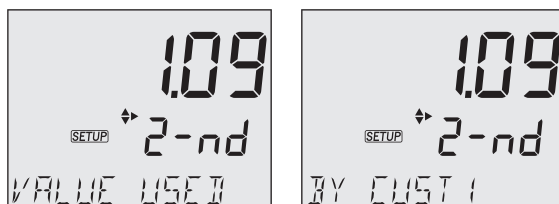

- "VALUE CALIBRATED WITH CUST1" or "VALUE CALIBRATED WITH CUST2" is displayed when setting a CUST1 or CUST2 value already used in a previous saved calibration.



Messages Displayed During Measurement

- "OUT CAL RNG" is displayed when the measured value is outside calibration range. The option has to be enabled (see Out of Calibration Range in SETUP section).

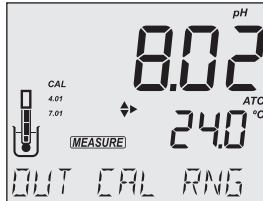

- "OUT OF SPEC" message is displayed when measured parameter and / or temperature are out of range.

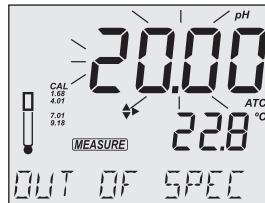
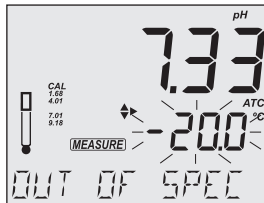

9. ORP

Connect an ORP electrode to the instrument and turn it on (see ACCESSORIES section).

9.1. PREPARATION

For accurate ORP measurements, the surface of the electrode must be clean and smooth. Pretreatment solutions are available to condition the electrode and improve its response time (see ACCESSORIES section).

The ORP range is factory calibrated.

Note: For direct ORP measurements, use an ORP probe. MA9020 ORP Solution can be used to confirm that the ORP sensor measures correctly. mV readings are not temperature compensated.

9.2. MEASUREMENT

1. Press the RANGE/▶ until the display changes to mV mode.
2. Remove the probe protective cap and immerse the tip approximately 4 cm (1½") into the sample. Allow the reading to stabilize (⊗ tag turns off).

The ORP mV reading is displayed on the first LCD line.

The second LCD line displays the temperature of the sample.

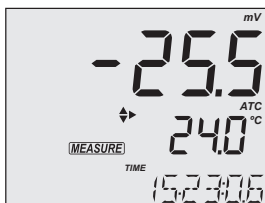

10. MEMORY FUNCTIONS (MW150)

MW150 can store one measured value (pH/ORP and temperature) with current calibration. The stored value can be recalled or deleted.

Memory Store

- Press MEM/CLEAR in measurement mode.
LCD displays "MEMORY". The instrument saves the currently measured value with calibration data and returns to measurement mode.

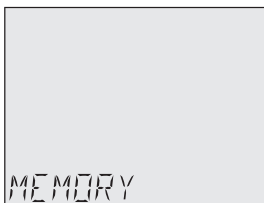

Memory Recall

- Press MR.
LCD displays the previously stored value.
- Press ▲▼ keys to see all measurement information (calibration data, time and date).
- If required press RANGE/▶ to switch between pH and ORP mV values.

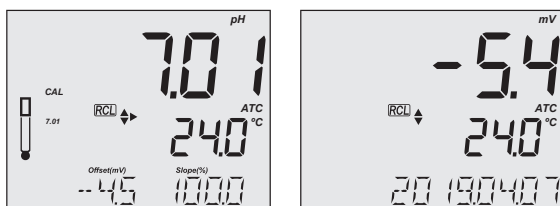

Memory Clear

- Press MR then MEM/CLEAR.
LCD displays "CLEARING". The instrument deletes the saved value and returns to measurement mode.



11. LOGGING (MW151)

MW151 supports three types of logging: manual log on demand, log on stability and interval logging. See Log Type in **MW151** SPECIFIC SETUP section.

The meter can hold up to 1000 log records. Up to 200 for manual log on demand, up to 200 for log on stability and up to 1000 for interval logging. See DATA MANAGEMENT section.

Note: *An interval logging lot can hold up to 600 records. When an interval logging session exceeds 600 records, another lot file is automatically generated.*

11.1. TYPES OF LOGGING

Manual log on demand

- Readings are logged each time LOG/CLEAR is pressed.
- All manual readings are stored in a single lot (i.e. records made on different days share the same lot).

Log on stability

- Readings are logged each time LOG/CLEAR is pressed and stability criteria is reached.
- Stability criteria can be set to fast, medium or accurate.
- All stability readings are stored in a single lot (i.e. records made on different days are logged in the same lot).

Interval logging

- Readings are logged continuously at a set time interval (e.g. every 5 or 10 minutes).
- Records are added to it until the session stops.
- For each interval logging session, a new lot is created.

Note: *At the end of the logging session the meter returns to measurement screen.*

A complete set of GLP information is stored with each log. See GLP section for details.

Manual Log on Demand

1. From the Setup mode, set Log Type to MANUAL.
2. From the measurement screen press LOG/CLEAR.
LCD displays "PLEASE WAIT". The LOG ### "SAVED" screen displays stored log number.
"FREE" ### screen displays the number of available records.

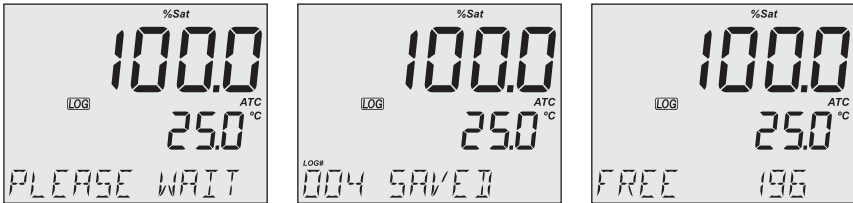

Log on Stability

1. From the Setup mode, set Log Type to STABILITY and the desired stability criteria.
2. From the measurement screen press LOG/CLEAR.
LCD displays "PLEASE WAIT" then "WAITING", until stability criteria is reached.

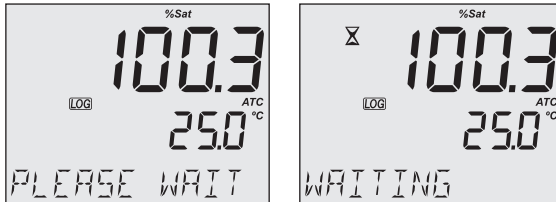

Note: Pressing ESC or LOG/CLEAR with "WAITING" displayed, exits without logging.

The LOG ### "SAVED" screen displays stored log number. "FREE" ### screen displays total number of available records.

Interval Logging

1. From the Setup mode, set Log Type to INTERVAL (default) and desired time interval.
2. From the measurement screen press LOG/CLEAR.
LCD displays "PLEASE WAIT". The LOG ### LOT ### screen displays the measurement log number (bottom left) and interval logging session lot number (bottom right).
3. Press RANGE/▶ during logging to display the number of available records ("FREE" ###).
Press RANGE/▶ again to return to return to active logging screen.
4. Press LOG/CLEAR again (or ESC) to end current interval logging session.
LCD displays "LOG STOPPED".

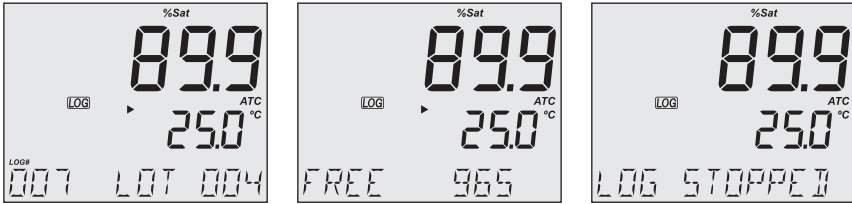

Interval Logging Warnings

"OUT OF SPEC"	Measurement is out of specified range. Log continues.
"MAX LOTS"	Maximum number of lots reached (100). Cannot create new lots.
"LOG FULL"	Log space is full (1000 logs limit was reached). Logging stops.

11.2. DATA MANAGEMENT

- A lot contains 1 to 600 log records (saved measurement data).
- Maximum number of lots that can be stored is 100, excluding Manual and Stability.
- Maximum number of log records that can be stored is 1000, across all lots.
- Manual and Stability logs can store up to 200 records (each).
- Interval logging sessions (across all 100 lots) can store up to 1000 records. When a logging session exceeds 600 records a new lot will be created.
- Lot names are automatically allocated by the meter from 001 up to 999 incrementally, even after some lots have been deleted. If max number of lots is reached (e.g. lot name DOLOT100) and 50 lots are deleted, another 50 lots from DOLOT101 to DOLOT150, can be stored.
- Once lot name 999 is assigned, to reset lot naming to 001, all lots have to be deleted. See Deleting Data section.

11.2.1. Viewing Data

1. Press RCL to access the logged data.
LCD displays "PLEASE WAIT" followed by "LOG RECALL" with ACCEPT tag blinking and the number of stored logs.

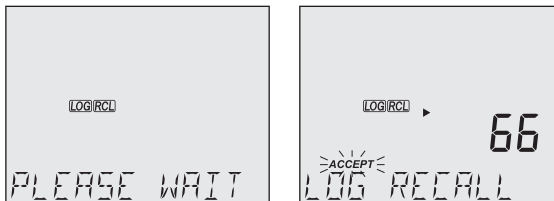

Note: Press RANGE/▶ to export all saved lots to external storage.

2. Press GLP/ACCEPT to confirm.
3. Use ▲▼ keys to select the lot type (MANUAL, STABILITY or INTERVAL ###).

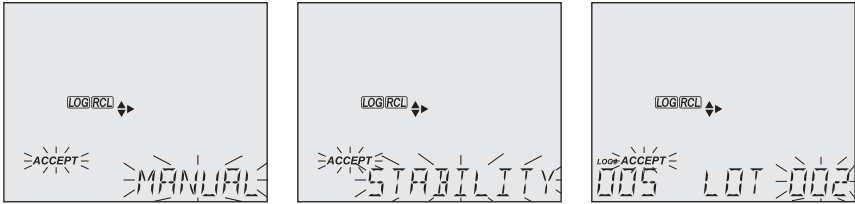

Note: Press RANGE/▶ to export only the selected lot to external storage.

4. Press GLP/ACCEPT to confirm.
5. With a lot selected, use ▲▼ keys to view the records stored in that lot.
6. Press RANGE/▶ to view, additional log data on the third LCD line: altitude, salinity, date, time, calibration points, lot info.

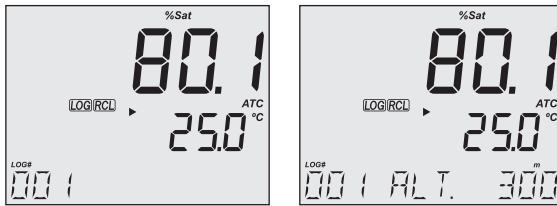

11.2.2. Deleting Data

Manual Log on Demand & Stability Log

1. Press RCL to access the logged data.
LCD displays "PLEASE WAIT" followed by "LOG RECALL" with ACCEPT tag blinking and the number of stored logs.
2. Press GLP/ACCEPT to confirm.
3. Use ▲▼ keys to select MANUAL or STABILITY lot type.

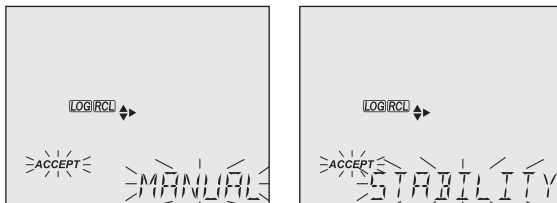

4. With a lot selected, press LOG/CLEAR to delete entire lot.
"CLEAR" is displayed with ACCEPT tag and lot name blinking.

- Press GLP/ACCEPT to confirm (to exit, press ESC or CAL/EDIT or LOG/CLEAR). "PLEASE WAIT" with ACCEPT tag blinking is displayed, until the lot is deleted. After the selected lot has been deleted, "CLEAR DONE" displays briefly. Display shows "NO MANUAL / LOGS" or "NO STABILITY / LOGS".

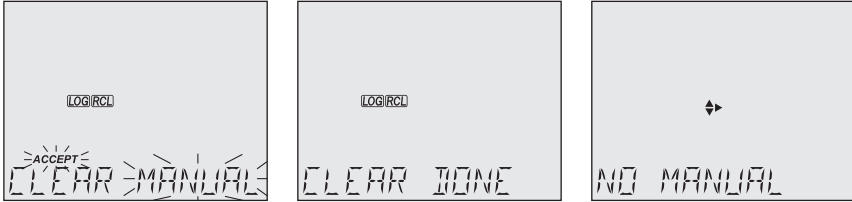

Individual Logs / Records

- Press RCL to access the logged data. LCD displays "PLEASE WAIT" followed by "LOG RECALL" with ACCEPT tag blinking and the total number of logs.
- Press GLP/ACCEPT to confirm.
- Use ▲▼ keys to select MANUAL or STABILITY lot type.
- Press GLP/ACCEPT to confirm.
- Use the ▲▼ to navigate between logs. Log record number displays on the left.
- With desired log record selected, press LOG/CLEAR to delete. "DELETE" is displayed with ACCEPT tag and log ### blinking.
- Press GLP/ACCEPT to confirm (to exit, press ESC or CAL/EDIT or LOG/CLEAR). "DELETE" and Log ### blinking is displayed, until the log is deleted. After the log has been deleted "CLEAR DONE" message displays briefly. Display shows logged data of the next log ###.

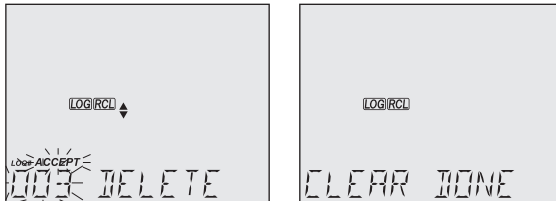

Note: Logs stored within an interval lot can not be deleted individually.

Log on Interval

1. Press RCL to access the logged data.
LCD displays "PLEASE WAIT" followed by "LOG RECALL" with ACCEPT tag blinking and the total number of logs.
2. Press GLP/ACCEPT to confirm.
3. Use ▲▼ keys to select an interval logging lot number.
The LOG ### LOT ### screen displays selected lot number (bottom right) and total logs stored in lot (bottom left).
4. Press GLP/ACCEPT to confirm (to exit, press ESC or CAL/EDIT; or LOG/CLEAR).
5. With the lot selected, press LOG/CLEAR to delete entire lot.
"CLEAR" is displayed with ACCEPT tag and lot name blinking.

Note: Use ▲▼ keys to select a different lot number.

6. Press GLP/ACCEPT to confirm (to exit, press ESC or CAL/EDIT or LOG/CLEAR).
"PLEASE WAIT" with ACCEPT tag blinking is displayed, until the lot is deleted.
After deletion "CLEAR DONE" message displays briefly.
Display shows the previous lot ###.

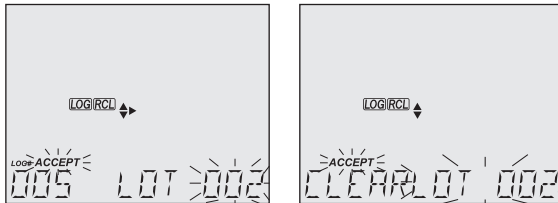

Delete All

1. Press RCL to access the logged data.
LCD displays "PLEASE WAIT" followed by "LOG RECALL" with ACCEPT tag blinking and the number of stored logs.
2. Press LOG/CLEAR to delete all logs.
"CLEAR ALL" is displayed with ACCEPT tag blinking.
3. Press GLP/ACCEPT to confirm (to exit, press ESC or CAL/EDIT; or LOG/CLEAR).
"PLEASE WAIT" is displayed with a percentage counter, until all logs are deleted.
After deletion "CLEAR DONE" message displays briefly.
Display returns to the log recall screen.

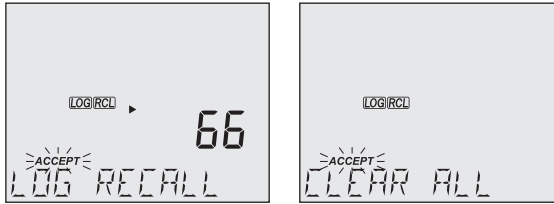

11.2.3. Exporting Data

PC Export

1. With the meter on, use the supplied micro USB cable to connect to a PC.
2. Press SETUP then CAL/EDIT.
3. Use the ▲▼ keys and select "EXPORT TO PC".
The meter is detected as a removable drive. LCD displays the PC icon.
4. Use a file manager to view or copy files on the meter.

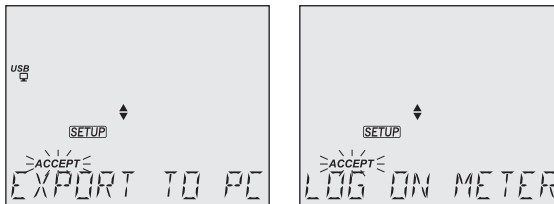

When connected to a PC, to enable logging:

- Press LOG/CLEAR. LCD displays "LOG ON METER" with ACCEPT tag blinking.
- Press GLP/ACCEPT. Meter disconnects from the PC and the PC icon is no longer displayed.
- To return to "EXPORT TO PC" mode, follow steps 2 and 3 above.

Exported data file details:

- The CSV file (comma separated values) may be opened with a text editor or spreadsheet application.
- The CSV file encoding is Western Europe (ISO-8859-1).
- Field separator may be set as comma or semicolon. See Separator Type in **MW151 SPECIFIC SETUP** section.
- Interval log files are named ECLOT###, where ### is the lot number (e.g. ECLOT051).
- Manual log file is named ECLOTMAN and stability log file is named ECLOTSTA.

USB Export All

1. With the meter on, insert a USB flash drive into the micro USB port. If the flash drive does not have a micro USB connector, use an adapter.
2. Press RCL then RANGE/▶ to select the "EXPORT ALL" option.
3. Press GLP/ACCEPT to confirm.
LCD displays "EXPORTING" and the percentage counter, followed by "DONE" when export is completed. Display returns to the lot selection screen.

Note: The USB flash drive can be safely removed if the USB icon is not displayed. Do not remove the USB drive during export.

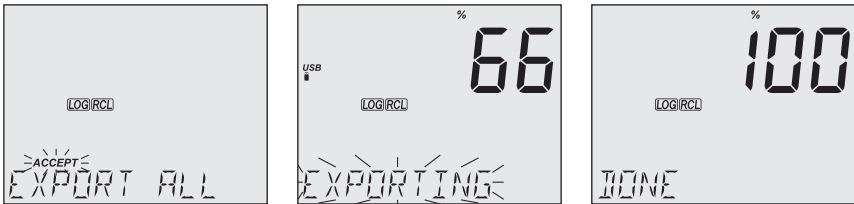

Overwriting existing data:

1. When the LCD displays "OVR" with LOT### blinking (USB icon is displayed), an identical named lot exists on the USB.
2. Press ▲▼ keys to select between YES, NO, YES ALL, NO ALL (ACCEPT tag blinking).
3. Press GLP/ACCEPT to confirm. Not confirming exits the export.
Display returns to lot selection screen.

USB Export Selected

Logged data can be transferred separately by lots.

1. Press RCL to access the logged data.
LCD displays "PLEASE WAIT" followed by "LOG RECALL" with ACCEPT tag blinking and the number of stored logs.
2. Press GLP/ACCEPT to confirm.
3. Use ▲▼ keys to select the lot type (MANUAL, STABILITY or interval ###)

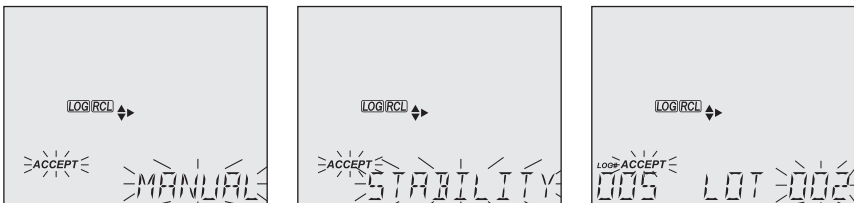

4. With the lot selected, press RANGE/▶ to export to USB flash drive.
 LCD displays "PLEASE WAIT" followed by "EXPORTING" with ACCEPT tag and selected lot name (MAN / STAB / ###) blinking.
 LCD displays "EXPORTING" and the percentage counter, followed by "DONE" when export is completed. Display returns to the lot selection screen.

Note: *The USB flash drive can be safely removed if the USB icon is not displayed. Do not remove the USB drive during export.*

Overwriting existing data.

1. When the LCD displays "EXPORT" with ACCEPT and lot number blinking (USB icon displayed), an identical named lot exists on the USB.
2. Press GLP/ACCEPT to continue. LCD displays "OVERWRITE" with ACCEPT tag blinking.
3. Press GLP/ACCEPT (again) to confirm. Not confirming exits the export.
 Display returns to lot selection screen.

Data Management Warnings

"NO MANUAL / LOGS"	No manual records saved. Nothing to display.
"NO STABILITY / LOGS"	No stability records saved. Nothing to display.
"OVR" with lot ### (blinking)	Identically named lots on USB. Select overwrite option.
"NO MEMSTICK"	USB drive is not detected. Data can not be transferred. Insert or check the USB flash drive.
"BATTERY LOW" (blinking)	When low battery, export is not executed. Recharge the battery.

Logged Data Warnings in CSV file

°C !	Probe used beyond its operation specifications. Data not reliable.
°C !!	Meter in MTC mode.

12. GLP

Good Laboratory Practice (GLP) allows the user to store and recall calibration data. Correlating readings with specific calibrations ensures uniformity and consistency.

Calibration data is stored automatically after a successful calibration.

- Press GLP/ACCEPT to view GLP data.
- Use the ▲ ▼ keys to scroll through the calibration data displayed on the third LCD line.
- Press ESC or GLP/ACCEPT to return to measurement mode.

GLP information is included with every data log.

pH Information

Calibration data displayed on the third LCD line:

- Offset and slope values (slope % is referenced to ideal slope value at 25 °C / 77 °F)
- Used buffers, temperature
- Time and date of the last calibration
- Electrode condition indicator after the last calibration (**MW151**)
- Calibration warnings

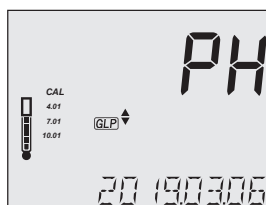
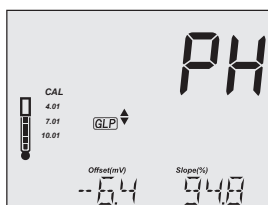

If a new buffer is used, which was not used in the last calibration, the buffer tag will be displayed with the tags for the previously used buffers displayed blinking.

When using custom buffers, "CUST1" and "CUST2" tags are displayed. If only one custom buffer is used, "CUST1" is displayed together with its value.

If Calibration Expired Warning is enabled, "EXP IN XDAYS" shows "X" days left until expiration and "CAL EXPIRED" indicates that calibration has expired.

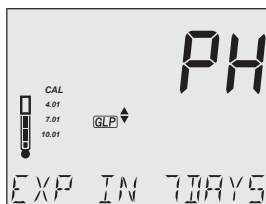

- "EXP WARN DIS" displays if Calibration Expired Warning is disabled.

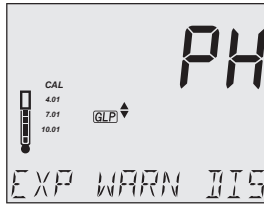

- "NO CAL" and CAL tag blinking displays if the instrument has not been calibrated.



13. TROUBLESHOOTING

SYMPTOMS	PROBLEM	SOLUTION
Slow response / excessive drift	Dirty pH electrode	Soak the electrode tip in MA9016 cleaning solution for 30 minutes, then follow the Cleaning procedure
Reading fluctuates up and down (noise)	Clogged/Dirty junction. Low electrolyte level (refillable electrodes only)	Clean the electrode. Refill with fresh MA9012 electrolyte
Full scale value displayed blinking	Reading out of range	Check if the sample is within measurable range; check electrolyte level and general electrode status
mV scale out of range	Dry membrane or dry junction	Soak electrode in MA9015 storage solution for at least 30 minutes
°C or °F displayed blinking	Out of order temperature probe	Replace temperature probe
Meter does not work with temperature probe	Broken temperature probe	Replace temperature probe
Meter fails to calibrate or gives faulty readings	Broken pH electrode	Replace electrode
"WRONG CAL" is displayed during pH calibration	Wrong or contaminated buffer	Check that buffer solution is correct and fresh
"Internal Er X"	Internal error	Restart the meter. If error persists, contact Milwaukee Technical Service.

14. ACCESSORIES

MA917B/1	Combination pH electrode, glass body, refillable
MA924B/1	ORP probe, glass body, refillable
SE-300	Double junction ORP platinum probe
MA831R	Stainless steel temperature probe
MA9001	pH 1.68 buffer solution (230 mL)
MA9004	pH 4.01 buffer solution (230 mL)
MA9006	pH 6.86 buffer solution (230 mL)
MA9007	pH 7.01 buffer solution (230 mL)
MA9009	pH 9.18 buffer solution (230 mL)
MA9010	pH 10.01 buffer solution (230 mL)
MA9012	Refilling solution for pH electrode (230 mL)
MA9015	Storage solution (230 mL)
MA9016	Electrode cleaning solution (230 mL)
MA9020	200-275 mV ORP solution (230 mL)
MA9112	pH 12.45 buffer solution (230 mL)
MA9310	12 VDC adapter, 220 V
MA9311	12 VDC adapter, 110 V
MA9315	Electrode holder

CERTIFICATION

Milwaukee Instruments conform to the CE European Directives.



RoHS
compliant



Disposal of Electrical & Electronic Equipment. Do not treat this product as household waste. Hand it over to the appropriate collection point for the recycling of electrical and electronic equipment.

Please note: proper product and battery disposal prevents potential negative consequences for human health and the environment. For detailed information, contact your local household waste disposal service or go to www.milwaukeeinstruments.com (US only) or www.milwaukeeinst.com.

RECOMMENDATION

Before using this product, make sure it is entirely suitable for your specific application and for the environment in which it is used. Any modification introduced by the user to the supplied equipment may compromise the meter's performance. For your and the meter's safety do not use or store the meter in hazardous environment. To avoid damage or burn, do not perform any measurement in microwave ovens.

WARRANTY

These instruments are warranted against defects in materials and manufacturing for a period of 3 years from the date of purchase. Electrodes and Probes are warranted for 6 months. This warranty is limited to repair or free of charge replacement if the instrument cannot be repaired. Damage due to accidents, misuse, tampering or lack of prescribed maintenance is not covered by warranty. If service is required, contact your local Milwaukee Instruments Technical Service. If the repair is not covered by the warranty, you will be notified of the charges incurred. When shipping any meter, make sure it is properly packaged for complete protection.



Milwaukee Instruments reserves the right to make improvements in design, construction and appearance of its products without advance notice.

THANK YOU FOR CHOOSING



Sales and Technical Service Contacts:

Milwaukee Electronics Kft.
Alsó-kikötő sor 11C
H-6726 Szeged - HUNGARY
tel: +36 62 428 050
fax: +36 62 428 051
www.milwaukeeinst.com
e-mail: sales@milwaukeeinst.com

Milwaukee Instruments, Inc.
2950 Business Park Drive
Rocky Mount, NC 27804 USA
tel: +1 (252) 443-3630
fax: +1 (252) 443-1937
www.milwaukeeinstruments.com
e-mail: sales@milwaukeeinstruments.com